

SR3904

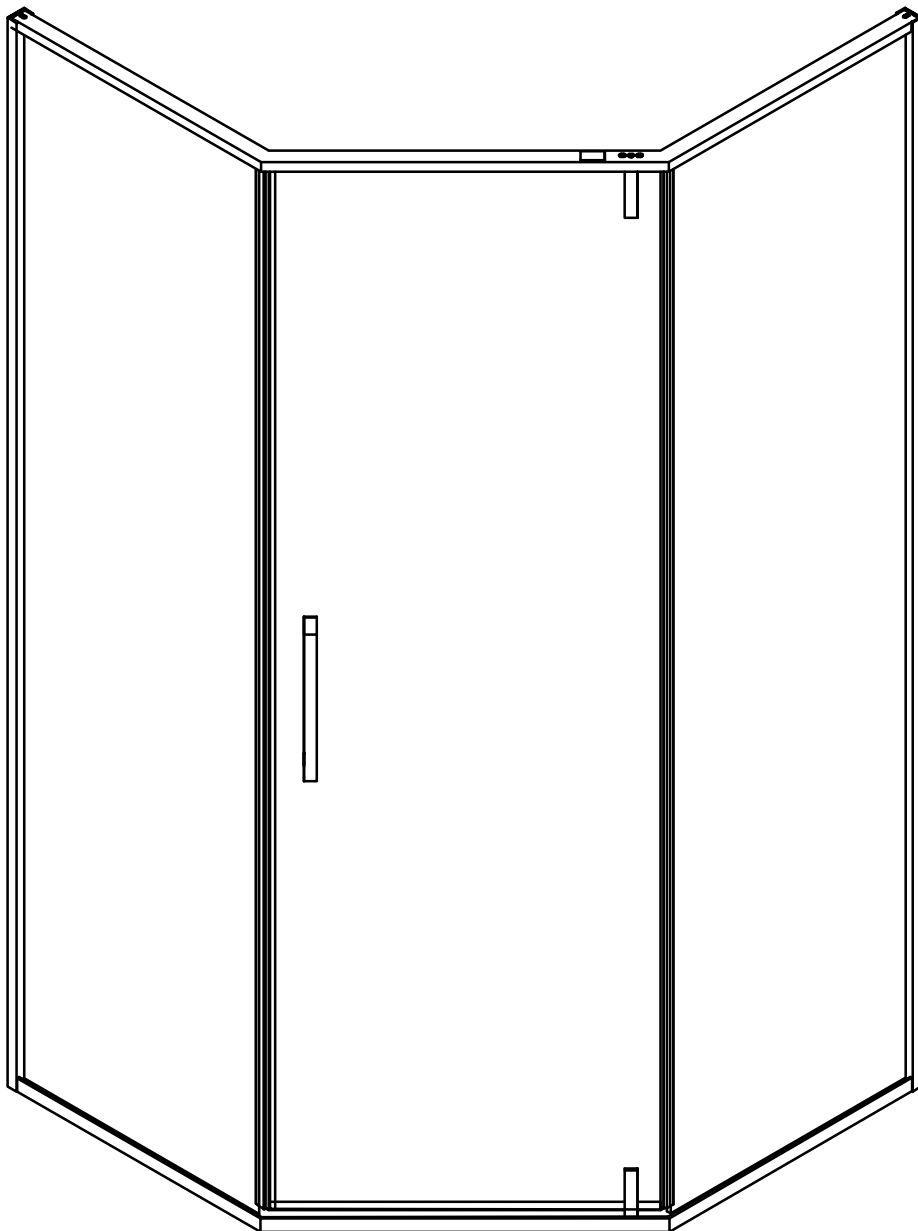

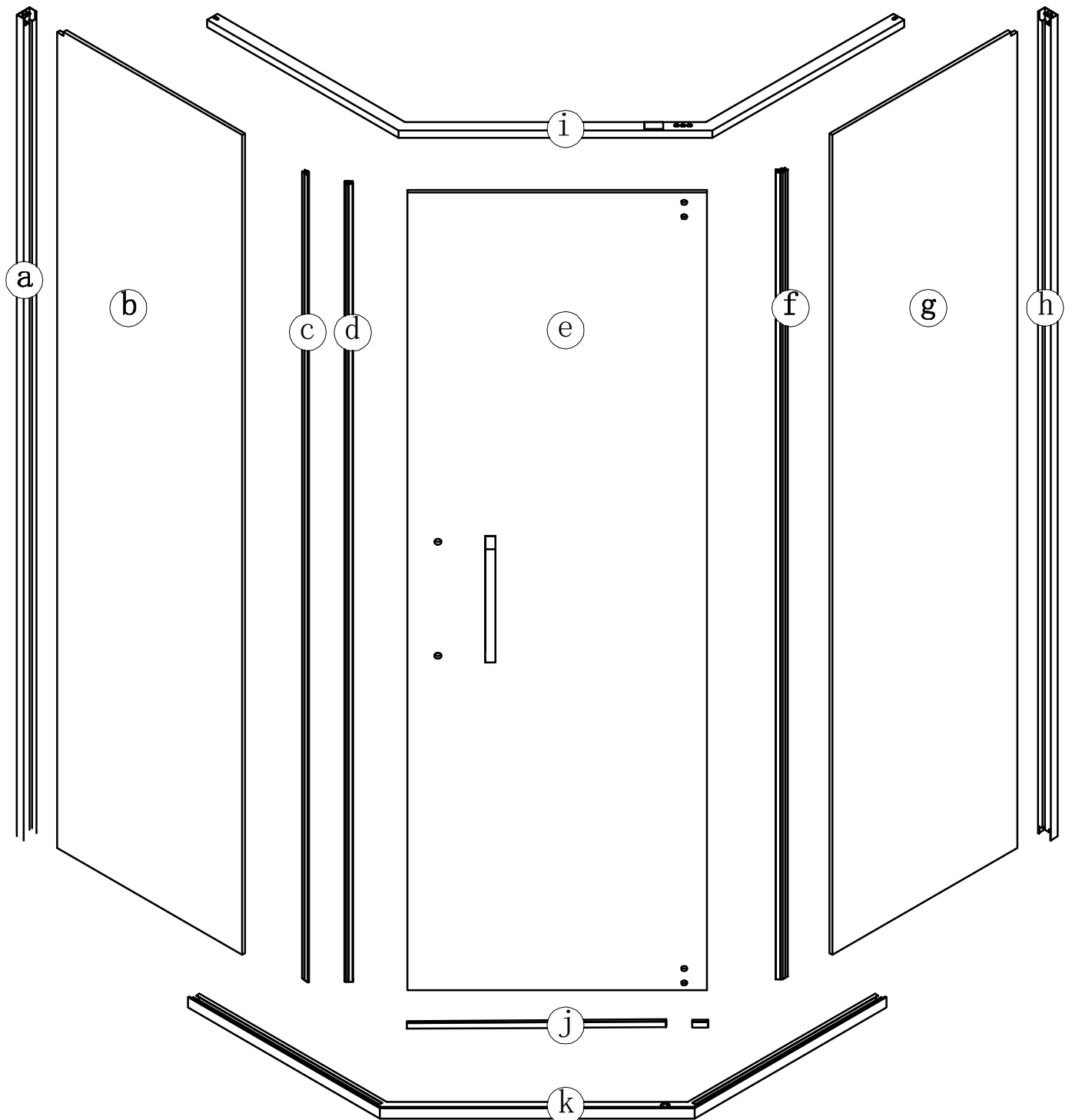

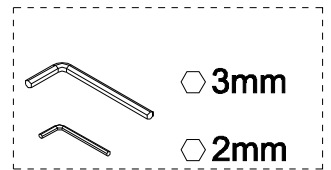
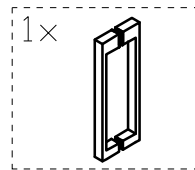
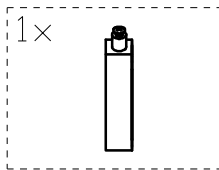
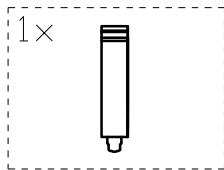
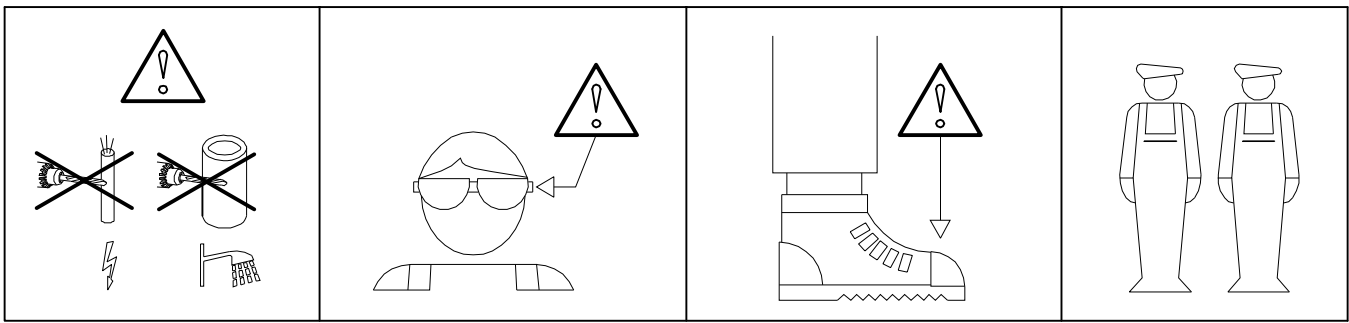
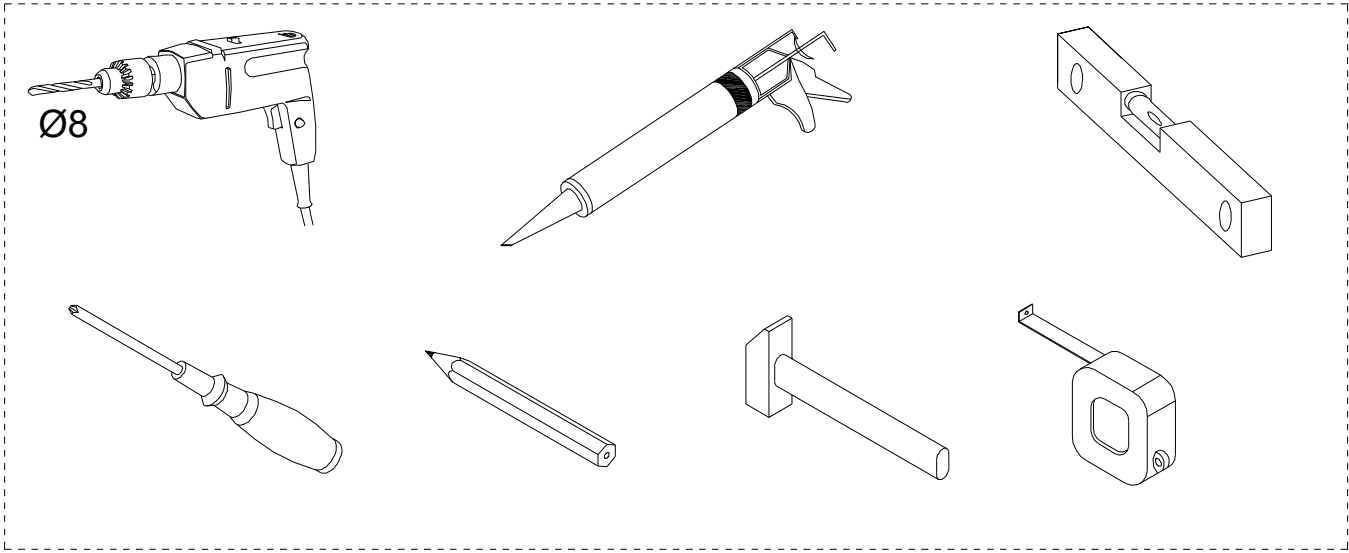

1

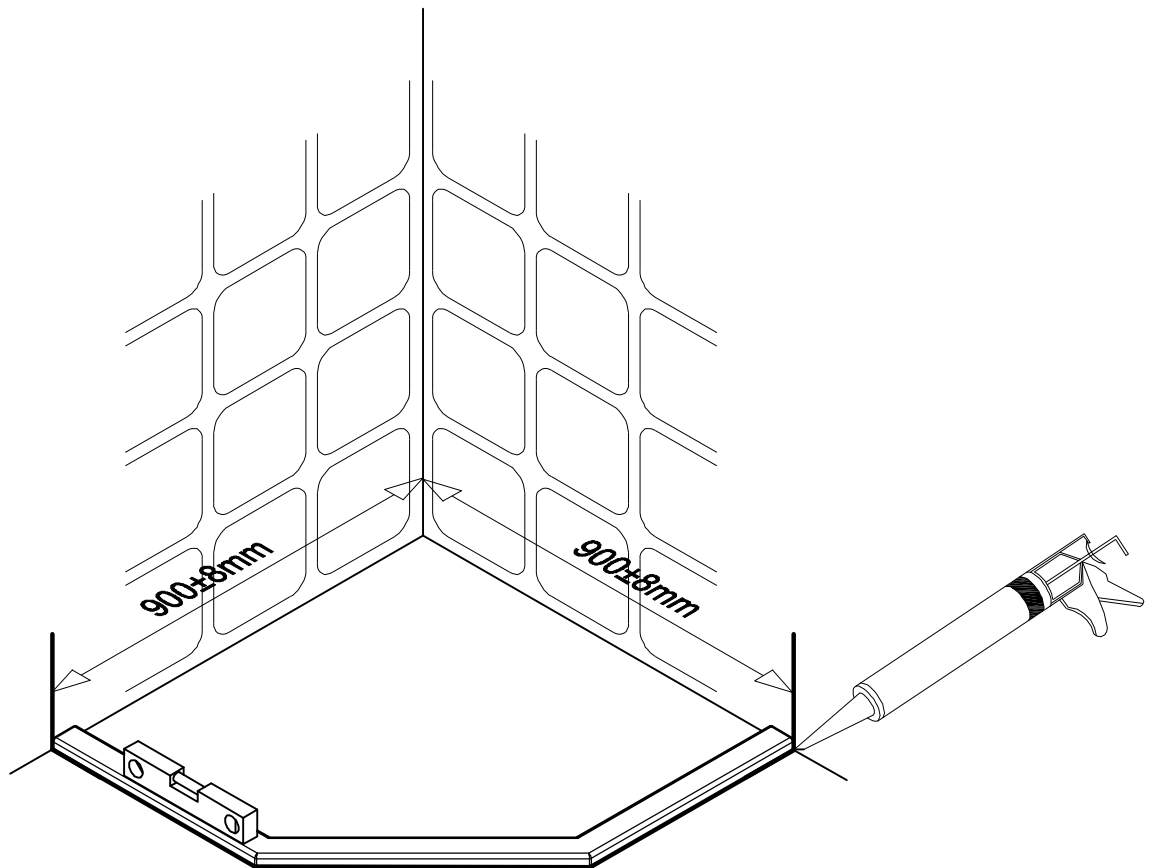

2

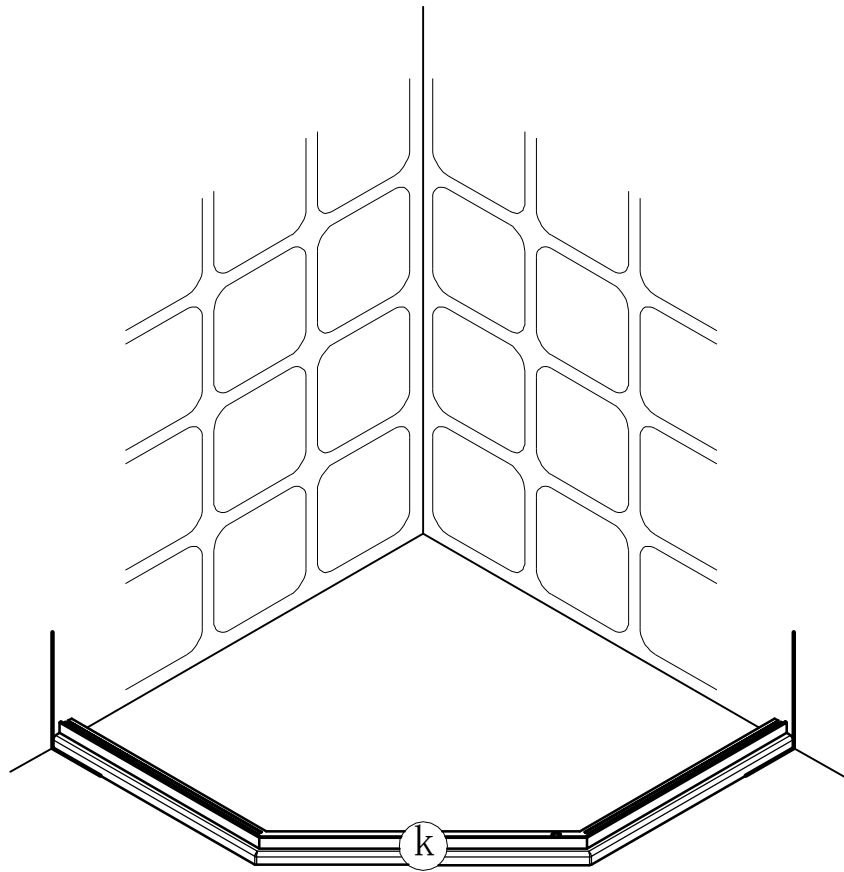

3

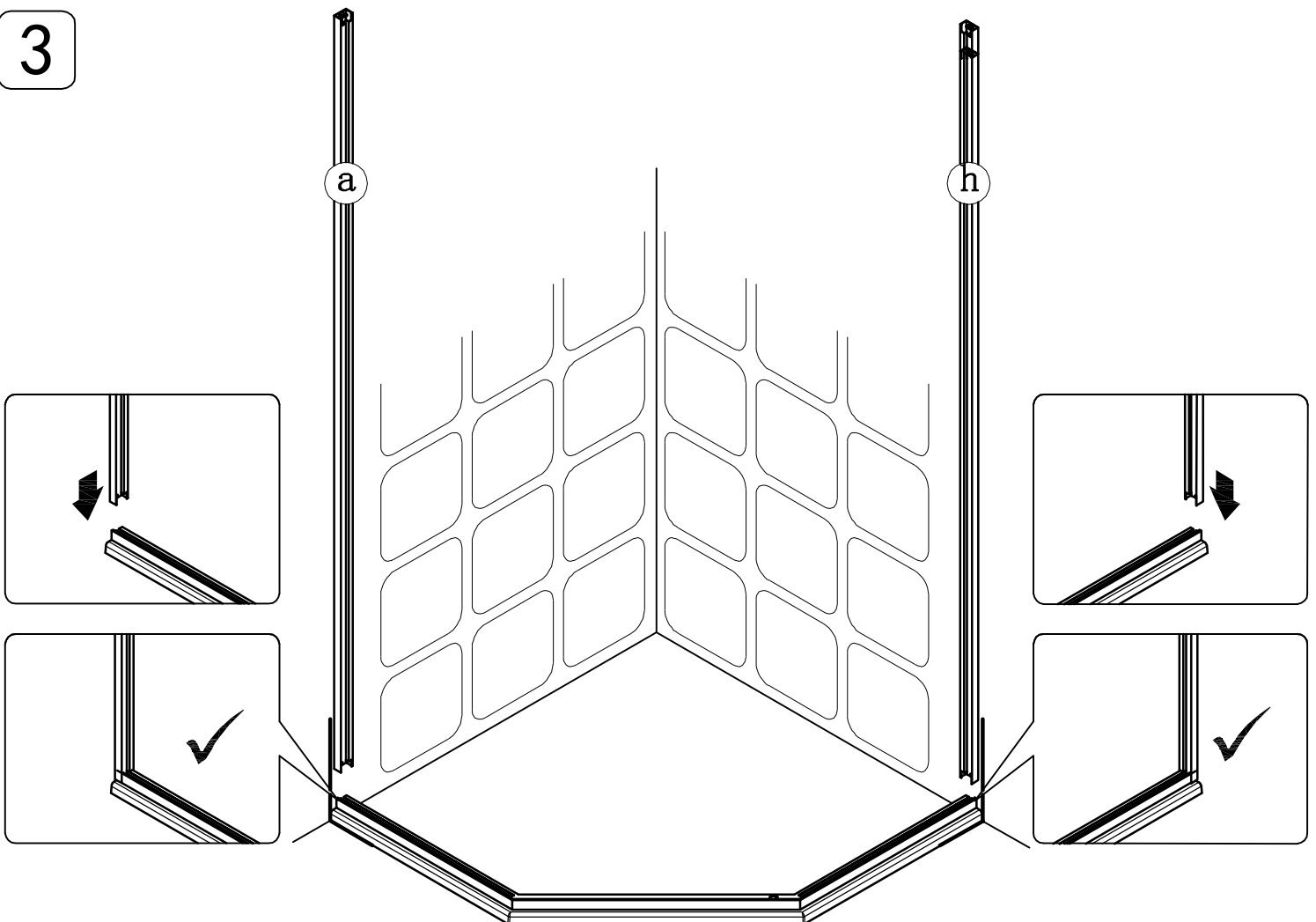

4

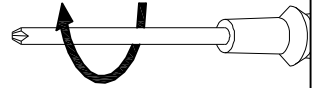
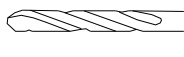
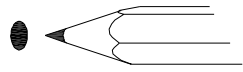

Ø8

Ø8

⊗5x40

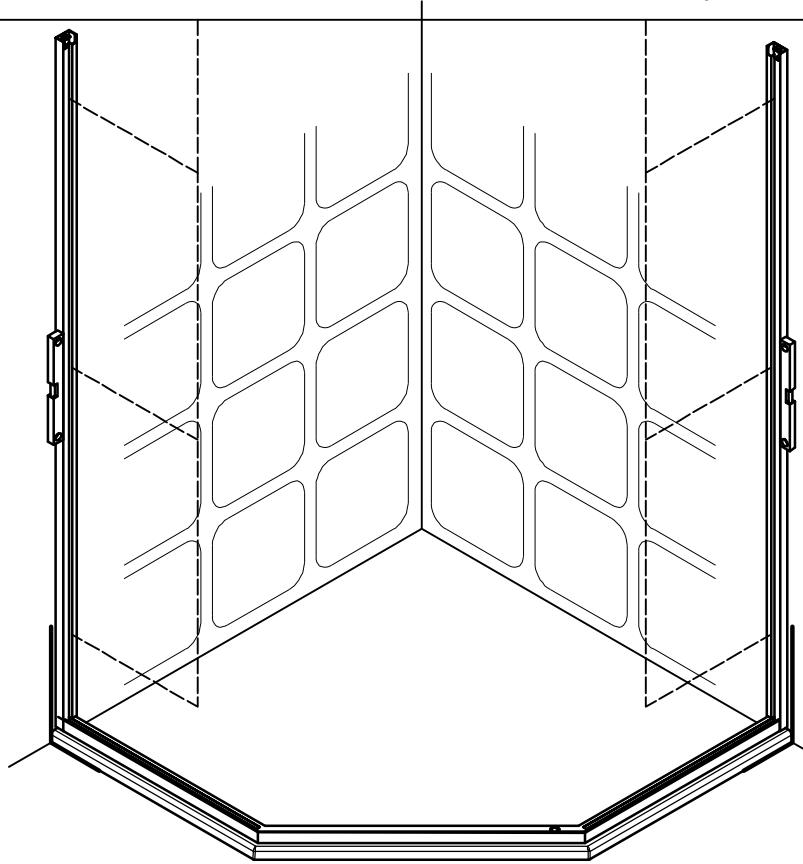

5

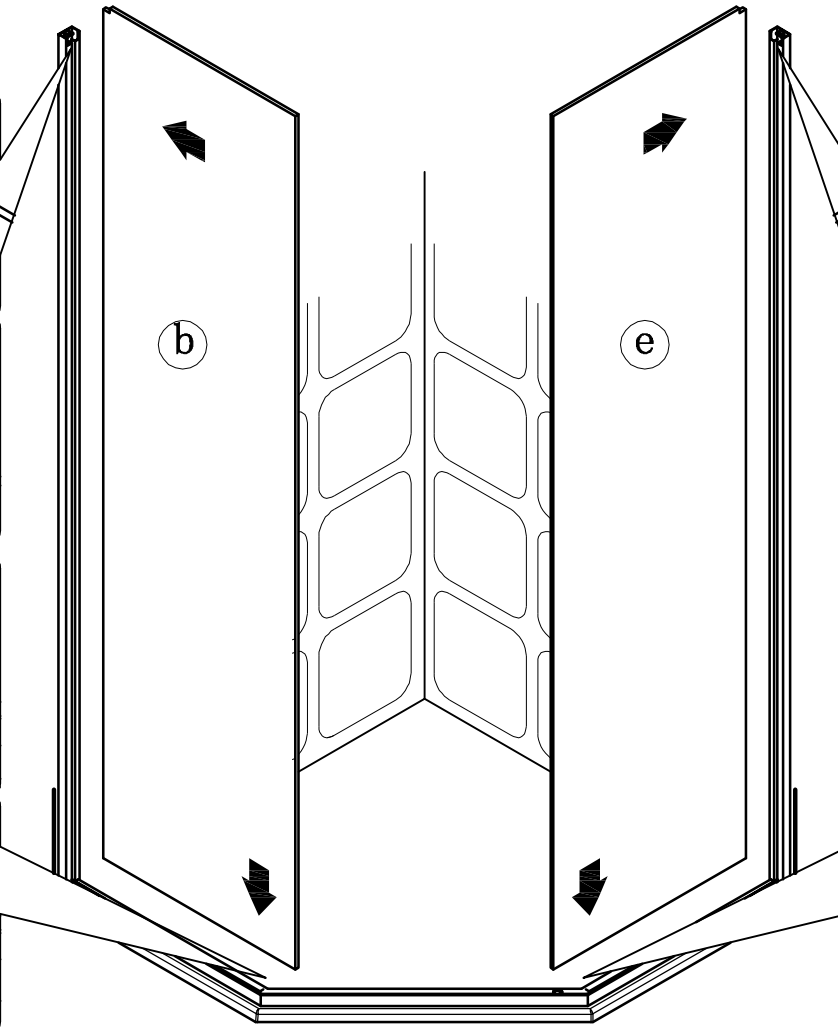
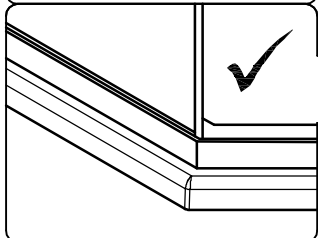
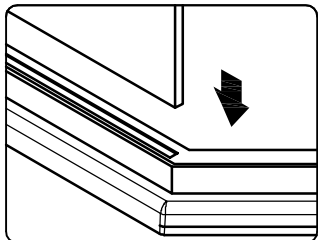
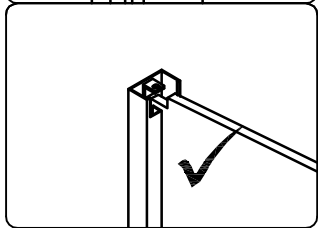
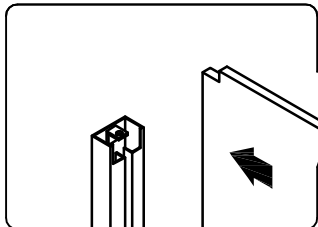

5

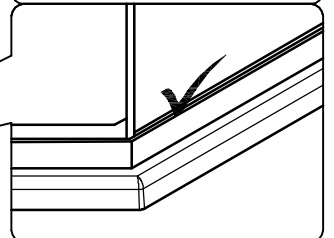
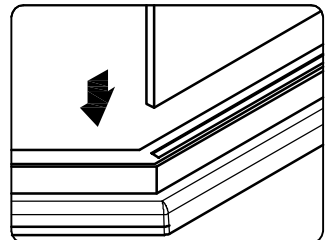
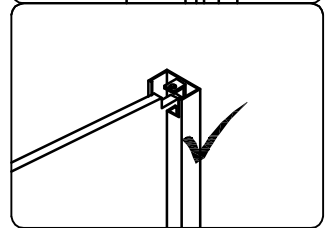
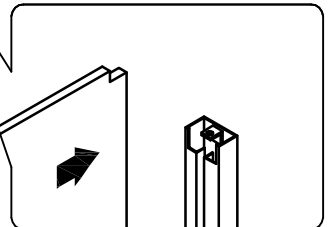

6

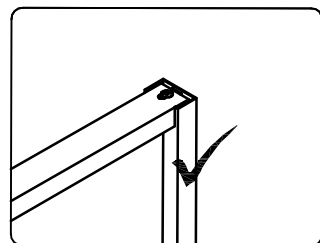
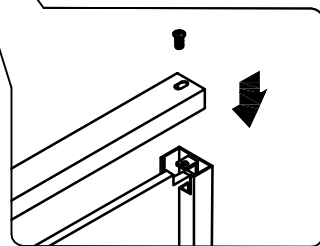
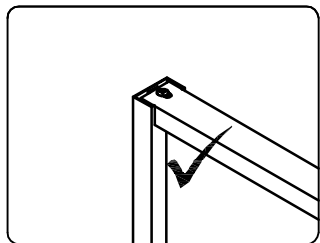
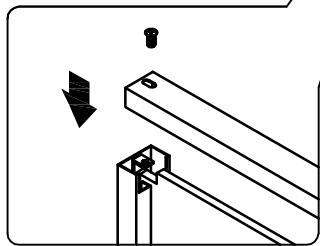
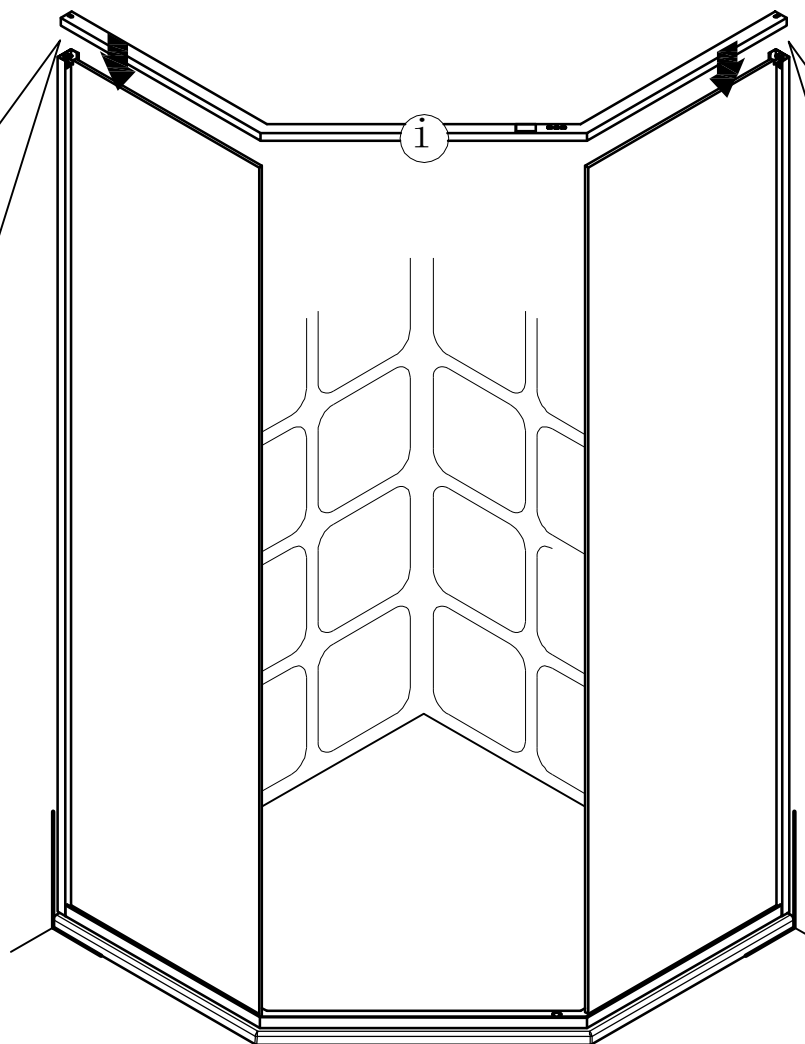

7

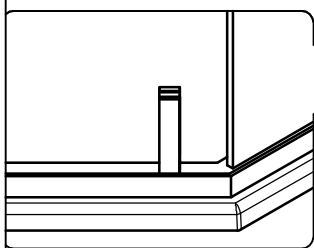
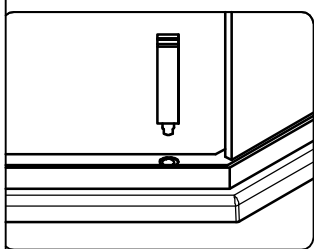
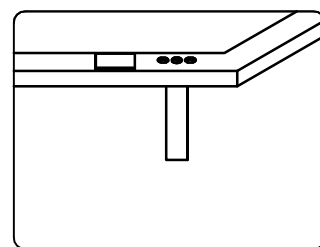
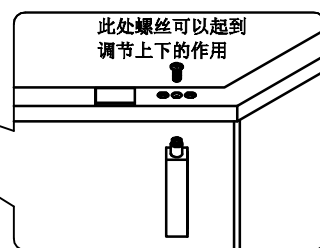
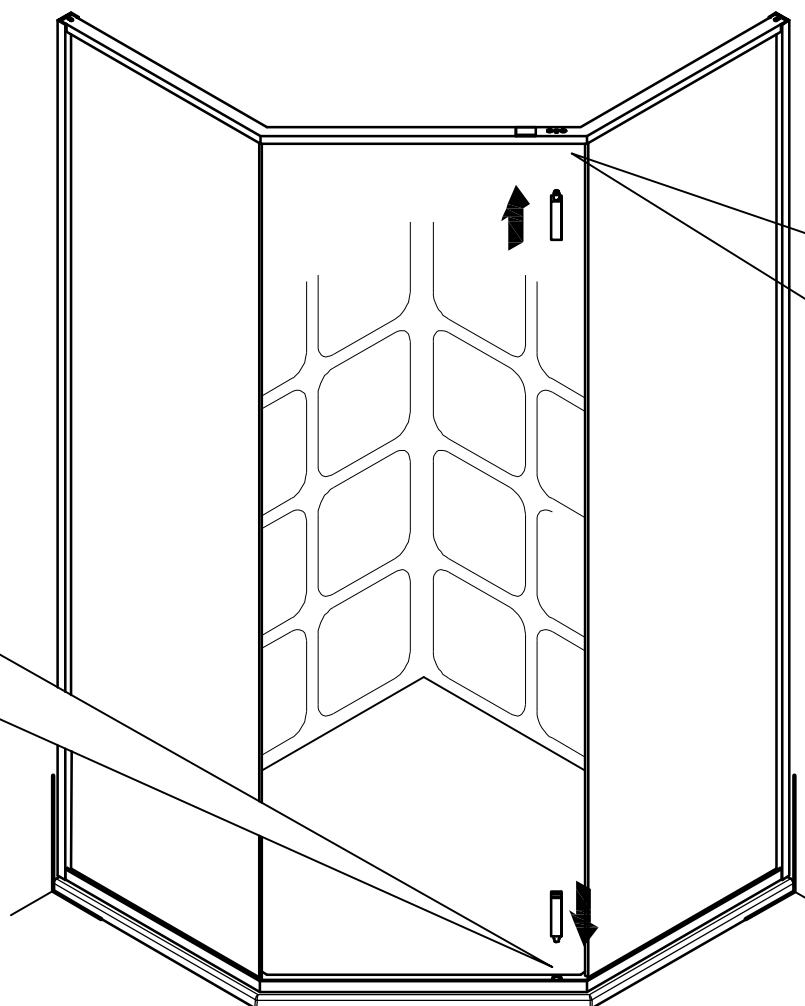

8

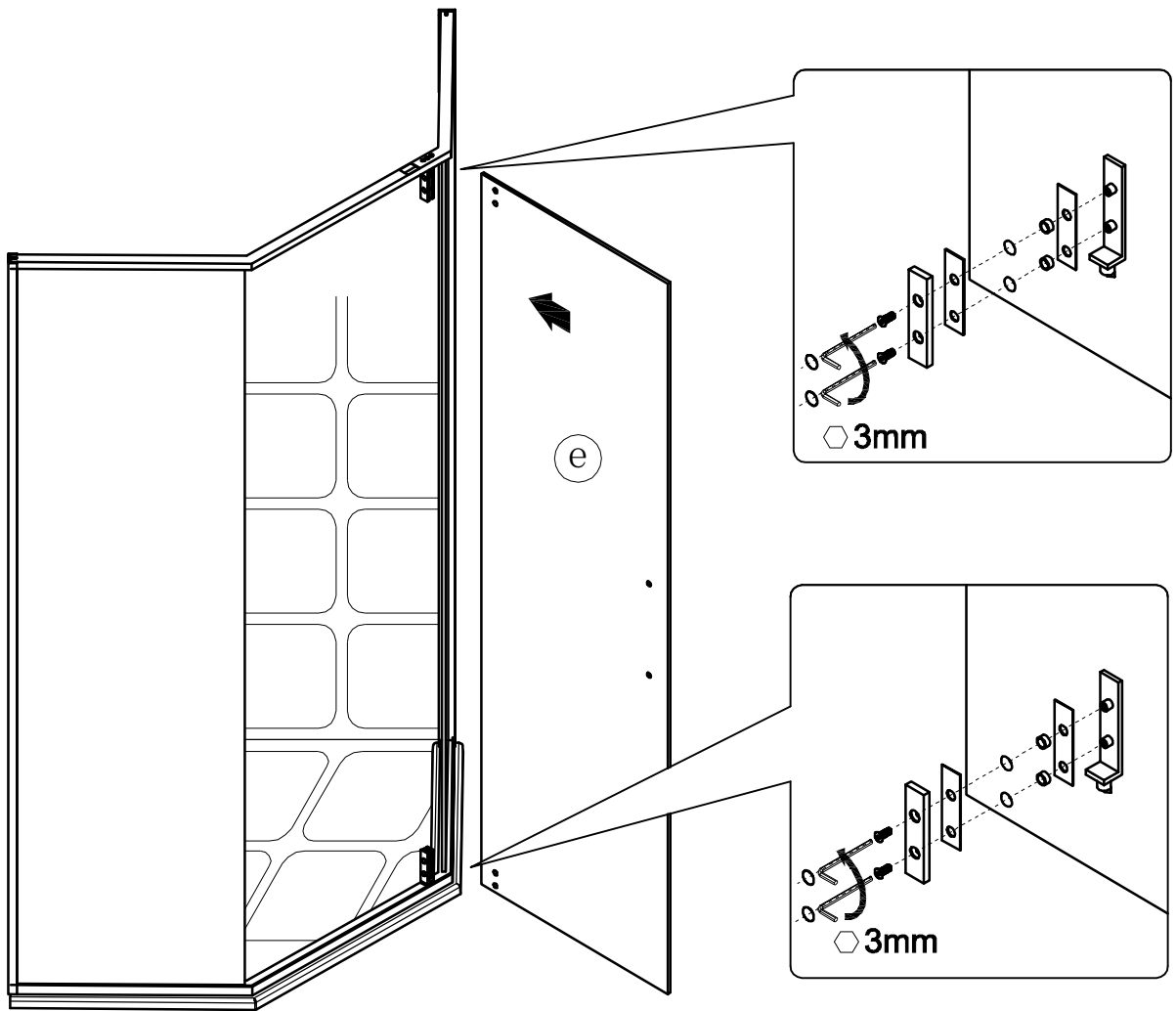

9

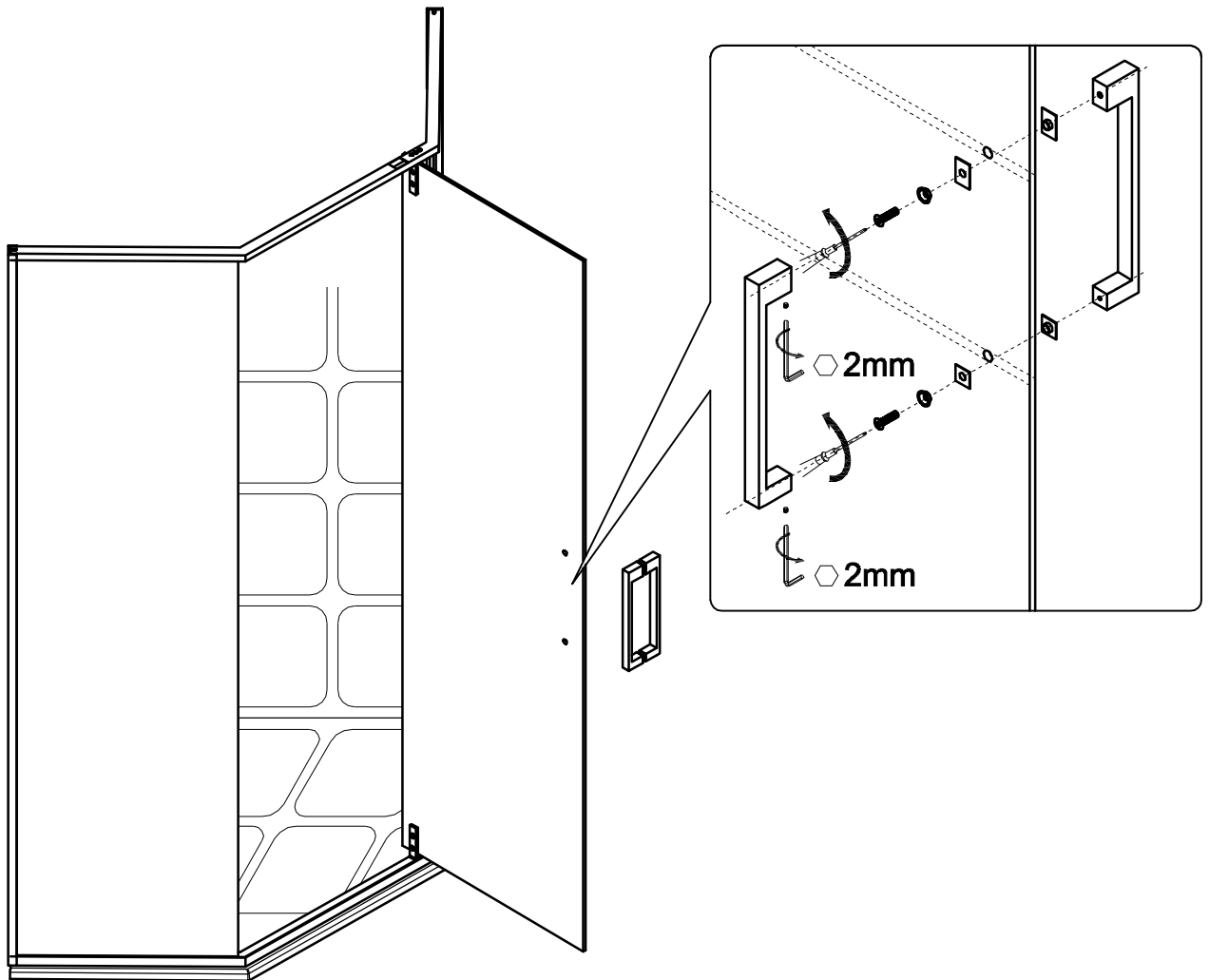

10

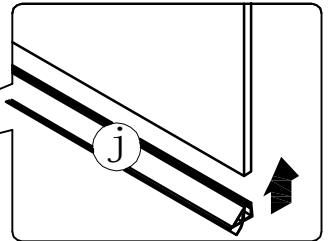
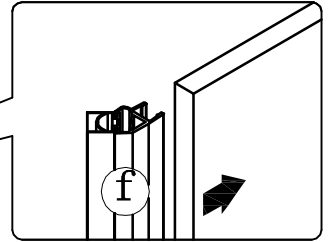
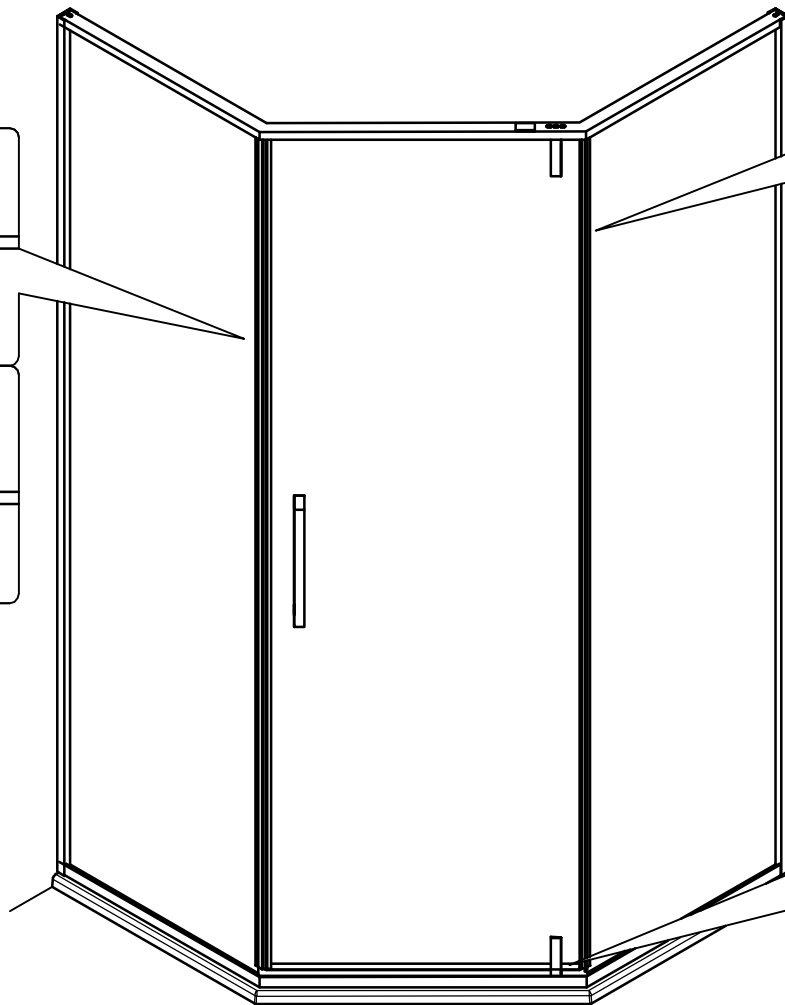
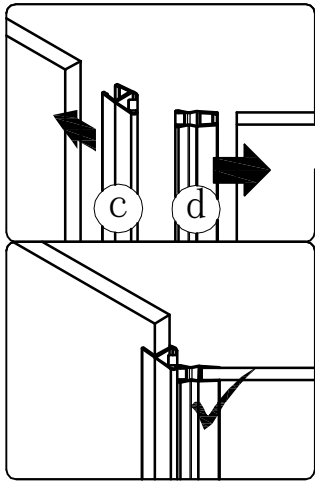

11

